

K-No.: 26780

### 100A Current Sensor

For the electronic measurement of currents:  
DC, AC, pulsed, mixed with a galvanic isolation  
between the primary circuit (high power) and the  
secondary circuit (electronic circuit)



Date: 28.08.2017

Customer: Standard type

Customers Part no:

Page 1 of 3

#### Description

- Closed loop (compensation)  
Current Sensor with magnetic probe
- Printed circuit board mounting
- Casing and materials UL-listed

#### Characteristics

- excellent accuracy
- very low offset current
- very low temperature dependency and offset current drift
- very low hysteresis of offset current
- short response time
- wide frequency bandwidth
- compact design
- reduced offset ripple

#### Applications

Mainly used for stationary operation in industrial applications:

- AC variable speed drives and servo motor drives
- static converters for DC motor drives
- Battery supplied applications
- Switched Mode Power Supplies (SMPS)
- Power supplies for welding applications
- Uninterruptable Power Supplies (UPS)

#### Electrical data - Ratings

$I_{PN}$	Primary nominal RMS current	100	A
$V_{OUT}$	Output voltage @ $I_P$	$V_{REF} \pm (0.625 \cdot I_P / I_{PN})$	V
$V_{OUT}$	Output voltage @ $I_P=0A, \vartheta_A=25^\circ C$	$V_{REF} \pm 0.0025$	V
$V_{REF}$	External Reference voltage range	0 ... 4	V
	Internal Reference voltage	$2.5 \pm 0.005$	V
$K_N$	Transformation ratio	1...3 : 1100	

#### Accuracy – Dynamic performance data

		min.	typ.	max.	Unit
$I_{P,max}$	Max. measuring range	$\pm 200$			A
X	Accuracy @ $I_{PN}, \vartheta_A = 25^\circ C$			0.7	%
$\epsilon_L$	Linearity			0.1	%
$V_{OUT}-V_{REF}$	Offset voltage @ $I_P = 0A, \vartheta_A = 25^\circ C$			$\pm 2.5$	mV
$\Delta V_O / V_{REF} / \Delta T$	Temperature drift of $V_{OUT}$ @ $I_P=0A, V_{REF}=2.5V, \vartheta_A$		3	10	ppm/ $^\circ C$
$t_r$	Response time		<1		$\mu s$
$t_{ra}$	Reaction time		<1		$\mu s$
$f_{BW}$	Frequency bandwidth	DC..100			kHz

#### General data

$\vartheta_A$	Ambient operation temperature	-40		85	$^\circ C$
$\vartheta_S$	Ambient storage temperature (acc. to M3101)	-40		85	$^\circ C$
m	Mass		15		g
$V_C$	Supply voltage	4.75	5	5.25	V
$I_C$	Supply current at $I_P = 0A$ and RT		16		mA

$^1)S_{clear}$	Clearance (component without solder pad)	10.2			mm
$^1)S_{creep}$	Creepage (component without solder pad)	10.2			mm
$^1)U_{sys}$	System voltage *determines impulse voltage acc. table 7			600	$V_{RMS}$
$^1)U_{AC}$	Working voltage *acc. table 10			1000	$V_{RMS}$
$^1)U_{PD}$	Rated discharge voltage *acc. table 24 with $U_{PD} = U_{AC} \cdot \sqrt{2}$ max. Potential Difference acc. to UL 508			1414	$V_{PEAK}$
				600	$V_{RMS}$

- 1) Constructed and manufactured and tested in accordance with IEC 61800-5-1:2007 (primary to secondary)  
Reinforced insulation, Insulation material group 1, Pollution degree 2, Overvoltage category III

The current sensor passed the EMI susceptibility tests (vertical and horizontal, one direction) according to the standard 61000-4-3:2010 at 20V/m, 80%AM@1kHz over the frequency range of 80MHz to 1000MHz, level a) with <2% variation of the  $V_{out}$  during the stress.

Date	Name	Issue	Amendment
		81	

Hrg.: R&D-PD NPI editor	Bearb.: DJ designer	KB-PM: Su check	freig.: BEF released
-------------------------	---------------------	-----------------	----------------------

K-No.: 26780

### 100A Current Sensor

For the electronic measurement of currents:  
DC, AC, pulsed, mixed with a galvanic Isolation  
between the primary circuit (high power) and the  
secondary circuit (electronic circuit)



Date: 28.08.2017

Customer: Standard type

Customers Part no:

Page 2 of 3

#### Mechanical outline (mm):

General tolerances DIN ISO 2768-c

Connections:

Pin Nr. 1-6: Ø1.5mm  
Pin Nr. 7-10: 0.6 x 0.7mm

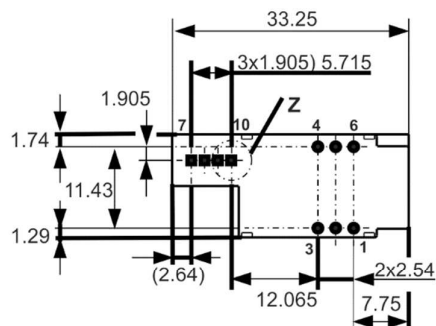

Tolerances grid distance  
±0.2mm

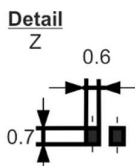

Marking:  
UL  
4647-X461  
F DC

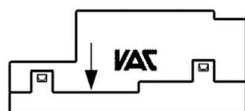
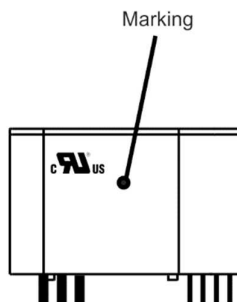
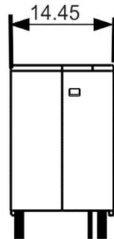
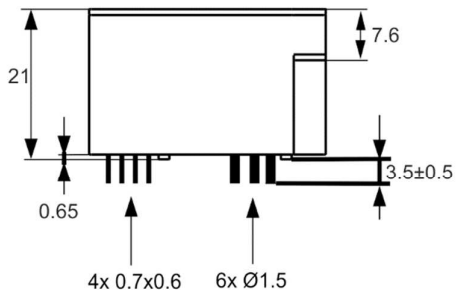

DC = Date Code  
F = Factory

#### Schematic diagram:

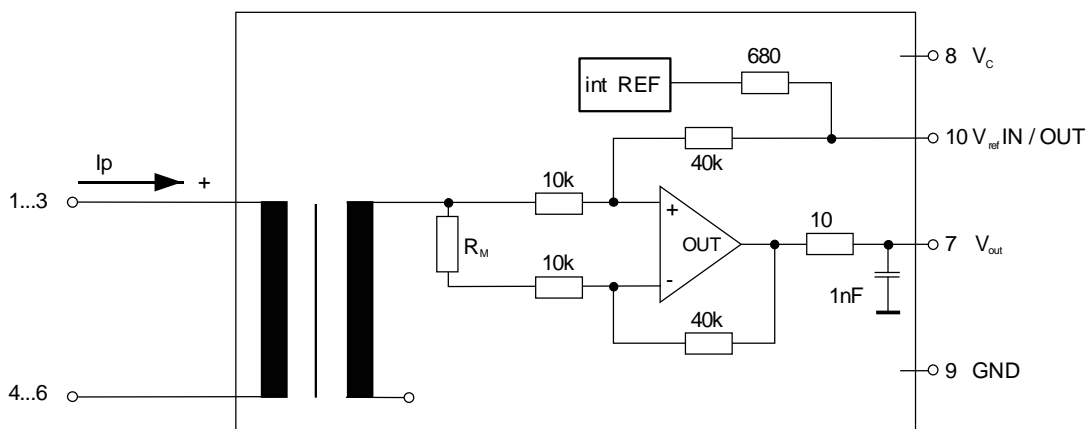

K-No.: 26780

### 100A Current Sensor

For the electronic measurement of currents:  
DC, AC, pulsed, mixed with a galvanic Isolation  
between the primary circuit (high power) and the  
secondary circuit (electronic circuit)



Date: 28.08.2017

Customer: Standard type

Customers Part no:

Page 3 of 3

#### Electrical data: (investigate by a type checking)

		min.	typ.	max.	Unit
$V_{C,tot}$	maximum supply voltage (without function)			7	V
$I_C$	Supply Current with primary current		$15mA + I_P * K_N + V_{OUT}/R_L$		mA
$I_{OUT,SC}$	Short circuit output current		$\pm 20$		mA
$R_P$	Resistance per primary winding @ $\vartheta_A = 25^\circ C$		0.3		m $\Omega$
$R_S$	Secondary coil resistance @ $\vartheta_A = 85^\circ C$			15	$\Omega$
$R_{i,REF}$	Internal resistance of Reference output		680		$\Omega$
$R_{i,Vout}$	Output resistance of $V_{OUT}$		10		$\Omega$
$R_L$	External recommended resistance of $V_{OUT}$	1			k $\Omega$
$C_L$	External recommended capacitance of $V_{OUT}$			1	nF
$X_{Ti} / \Delta T$	Temperature drift of X @ $\vartheta_A = -40^\circ C \dots 85^\circ C$			40	ppm/K
$\Delta V_O = \Delta(V_{OUT} - V_{REF})$	Sum of any offset drift including:		2	6	mV
$V_{Ot}$	Long term drift of $V_O$		1		mV
$V_{OT}$	Temperature drift of $V_O$ @ $\vartheta_A = -40^\circ C \dots 85^\circ C$		1		mV
$V_{OH}$	Hysteresis of $V_{OUT}$ @ $I_P = 0A$ (caused by $I_P = 10 \times I_{PN}$ )			1	mV
$\Delta V_O / \Delta V_C$	Supply voltage rejection ratio			1	mV/V
$V_{OSS}$	Offsetripple (with 1 MHz-Filter, first order)		19		mV <sub>PP</sub>
$V_{OSS}$	Offsetripple (with 100 kHz-Filter, first order)		5		mV <sub>PP</sub>
$V_{OSS}$	Offsetripple (with 20 kHz-Filter, first order)		2		mV <sub>PP</sub>
$C_k$	Maximum possible coupling capacity (primary - secondary)		5		pF
	Mechanical stress according to M3209/3 Settings: 10-2000Hz, 1min/oct., 2 hours			30	g

#### Routine Tests: (Measurement after temperature balance of the samples at room temperature, SC=significant characteristic)

$V_{OUT} (SC)$	(100%) M3011/6:	Output voltage ( $I_P = 3 \times 10A_{PEAK}$ )	$625 \pm 0.7\%$	mV
$V_O$	(100%) M3226:	Offset voltage	$\pm 2.5$	mV
$U_d$	(100%) M3014:	Test voltage, 1s	1.8	kV <sub>RMS</sub>
$U_{PDE}$	(AQL 1/S4)	Partial discharge voltage (extinction)	1.5	kV <sub>RMS</sub>
$U_{PDE} * 1.875$	M3024		1.875	

#### Type testing: (Precondition acc. to M3236)

$\hat{U}_W$	M3064	HV transient test 1,2 $\mu s$ / 50 $\mu s$ -Waveform 5 pulses $\rightarrow$ polarity +, 5 pulses $\rightarrow$ polarity -	8	kV
$U_d$	M3014	Test voltage (5s)	3.6	kV <sub>RMS</sub>
$U_{PDE}$	M3024	Partial discharge voltage (extinction)	1.5	kV <sub>RMS</sub>
$U_{PDE} * 1.875$			1.875	

#### Other instructions:

- Current direction: A positive output voltage vs.  $V_{REF}$  appears at point  $V_{OUT}$ , if primary current flows in direction of the arrow.
- Constructed, manufactured and tested in accordance with IEC 61800-5-1:2007.
- Temperature of the primary conductor should not exceed 100°C.
- Housing and bobbin material UL-listed: Flammability class 94V-0.
- Further standards: UL 508, file E317483, category NMTR2 / NMTR8

Hrg.: R&D-PD NPI  
editor

Bearb.: DJ  
designer

KB-PM: Su  
check

freig.: BEF  
released